

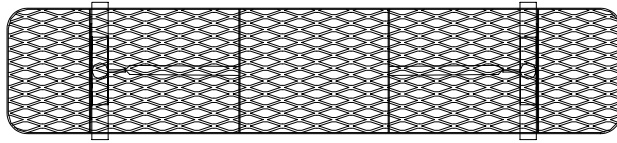

# 937-301

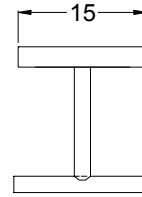

937-301 6FT  
SUPREME CHAMPION  
FREE STANDING  
BENCH WITHOUT BACK

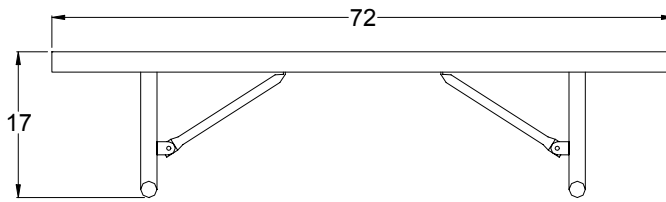

Part No.	Description	Qty.
622-113	6' Supreme Champion seat/back	1
631-110	Supreme Stand (Free Standing)	2
631-313	Brace (WO/Back)	2
516-058	3/8" x 1-1/2" SS Hex Bolt	8
516-028	3/8" SS Nylock Nut	8
516-023	3/8" SS Washer	16

- 1 Drill plastic out of the mounting holes on the stands, seat and braces using a 7/16" dia. drill bit.
- 2 Fasten the seat to the stands loosely and then fasten the braces to the stands and seat.
- 3 Make sure bench is level and tighten all of the bolts.

In Accordance to California law: WARNING This product contains a chemical know to the State of California to cause cancer and birth defects or other reproductive harm.

*Periodic check of bolt tightness recommended.*



## PREMIER POLYSTEEL

The Best Commercial Outdoor Furniture Available. Period.





# 937-302

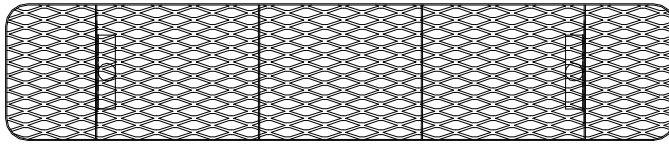

937-302 6FT  
SUPREME CHAMPION  
DIRECT BURY  
BENCH WITHOUT BACK

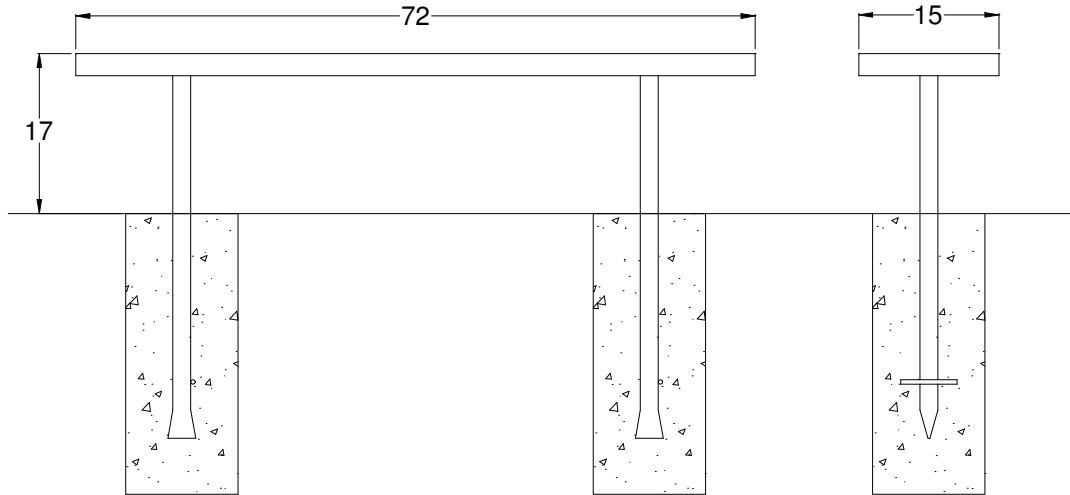

Part No.	Description	Qty.
622-113	6' Supreme Champion seat/back	1
631-120	Supreme Stand (Direct Bury)	2
516-058	3/8" x 1-1/2" SS Hex Bolt	4
516-028	3/8" SS Nylock Nut	4
516-023	3/8" SS Washer	8

- 1 Drill plastic out of the mounting holes on the stands, seat and braces using a 7/16" dia. drill bit.
- 2 Fasten the seat to the stands loosely and then fasten the braces to the stands and seat.
- 3 Make sure bench is level and tighten all of the bolts.

In Accordance to California law: WARNING This product contains a chemical know to the State of California to cause cancer and birth defects or other reproductive harm.

*Periodic check of bolt tightness recommended.*



## PREMIER POLYSTEEL

The Best Commercial Outdoor Furniture Available. Period.





# 937-305

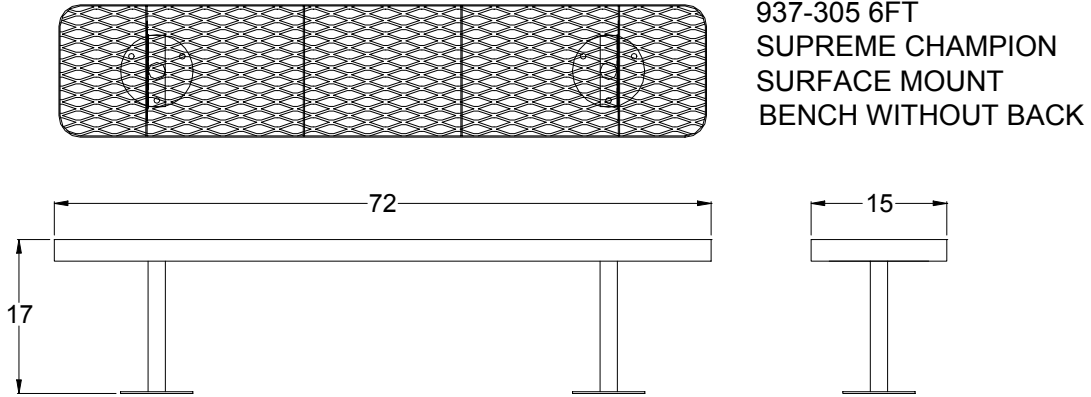

937-305 6FT  
SUPREME CHAMPION  
SURFACE MOUNT  
BENCH WITHOUT BACK

Part No.	Description	Qty.
622-113	6' Supreme Champion seat/back	1
633-111	Supreme Stand wo/Back (Surface mount)	2
516-058	3/8" x 1-1/2" SS Hex Bolt	4
516-028	3/8" SS Nylock Nut	4
516-023	3/8" SS Washer	8

- 1 Drill plastic out of the mounting holes on the stands and seat using a 7/16" dia. drill bit.
- 2 Fasten the seat to the stands loosely and then fasten the braces to the stands and seat.
- 3 Make sure bench is level and tighten all of the bolts.
- 4 Fasten to the floor with the appropriate fasteners.

In Accordance to California law: WARNING This product contains a chemical know to the State of California to cause cancer and birth defects or other reproductive harm.

*Periodic check of bolt tightness recommended.*



# 937-307

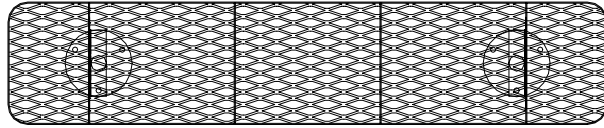

937-307 6FT  
SUPREME CHAMPION  
SURFACE MOUNT  
BENCH WITHOUT BACK

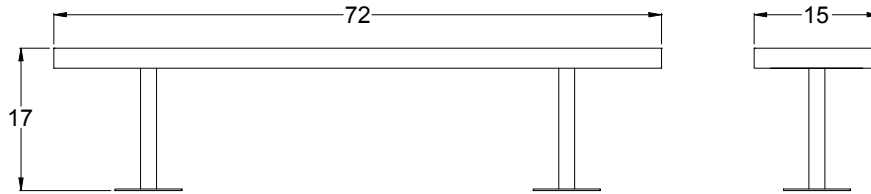

Part No.	Description	Qty.
622-113	6' Supreme Champion seat/back	1
633-111	Supreme Stand wo/Back (Surface mount)	2
516-058	3/8" x 1-1/2" SS Hex Bolt	4
516-028	3/8" SS Nylock Nut	4
516-023	3/8" SS Washer	8

- 1 Drill plastic out of the mounting holes on the stands and seat using a 7/16" dia. drill bit.
- 2 Fasten the seat to the stands loosely and then fasten the braces to the stands and seat.
- 3 Make sure bench is level and tighten all of the bolts.
- 4 Fasten to the floor with the appropriate fasteners.

In Accordance to California law: WARNING This product contains a chemical know to the State of California to cause cancer and birth defects or other reproductive harm.

*Periodic check of bolt tightness recommended.*



## PREMIER POLYSTEEL

The Best Commercial Outdoor Furniture Available. Period.





# 937-501

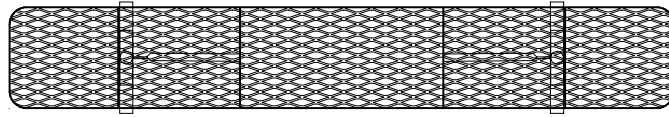

937-501 8ft  
SUPREME CHAMPION  
FREE STANDING  
BENCH WITHOUT BACK

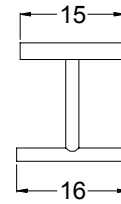
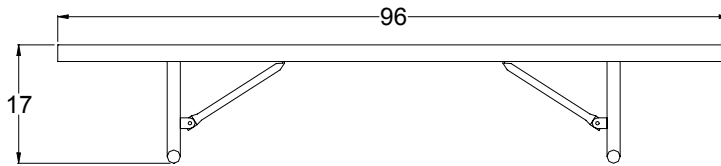

Part No.	Description	Qty.
622-115	8' Supreme Champion seat/back	1
631-110	Supreme Stand (WO/Back) (Free Standing)	2
631-313	Brace (WO/Back)	2
516-058	3/8" x 1-1/2" SS Hex Bolt	8
516-028	3/8" SS Nylock Nut	8
516-023	3/8" SS Washer	16

- 1 Drill plastic out of the mounting holes on the stands, seat and brace using a 7/16" dia. drill bit.
- 2 Fasten the seat to the stands loosely and then fasten the brace to the stands.
- 3 Make sure the bench is level and tighten all of the bolts.

In Accordance to California law: WARNING This product contains a chemical know to the State of California to cause cancer and birth defects or other reproductive harm.

*Periodic check of bolt tightness recommended.*



## PREMIER POLYSTEEL

The Best Commercial Outdoor Furniture Available. Period.





# 937-502

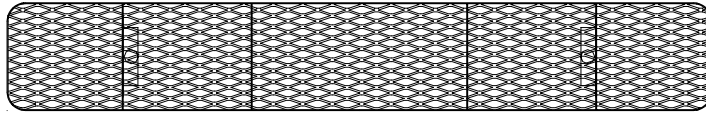

937-502 8ft  
SUPREME CHAMPION  
DIRECT BURY  
BENCH WITHOUT BACK

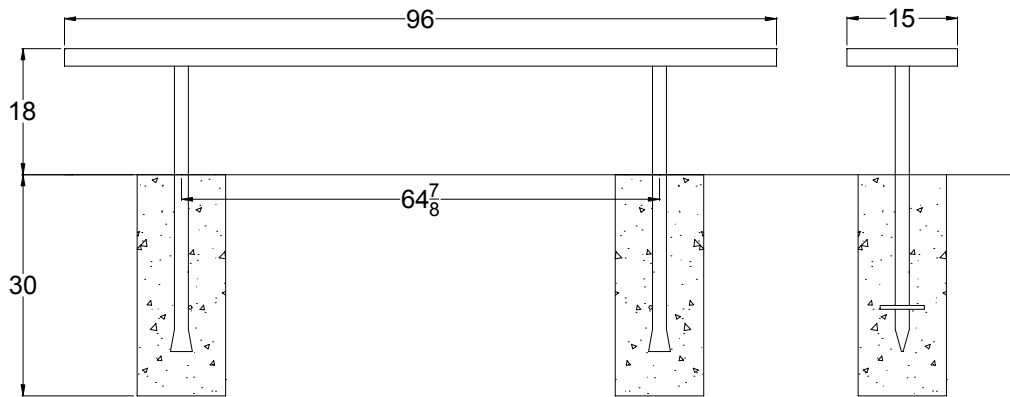

Part No.	Description	Qty.
622-115	8' Supreme Champion seat/back	1
631-120	Supreme Stand (WO/Back) (Direct Bury)	2
516-058	3/8" x 1-1/2" SS Hex Bolt	4
516-028	3/8" SS Nylock Nut	4
516-023	3/8" SS Washer	8

- 1 Drill plastic out of the mounting holes on the stands and the seat using a 7/16" dia. drill bit.
- 2 Attach seat to stands with 3/8" x 1-1/2" SS hex bolts, washers and nuts.
- 3 Secure in concrete footing as shown.

In Accordance to California law: WARNING This product contains a chemical know to the State of California to cause cancer and birth defects or other reproductive harm.

*Periodic check of bolt tightness recommended.*



## PREMIER POLYSTEEL

The Best Commercial Outdoor Furniture Available. Period.





# 937-507

937-507  
8' Champion Supreme bench  
without back, Surface Mount

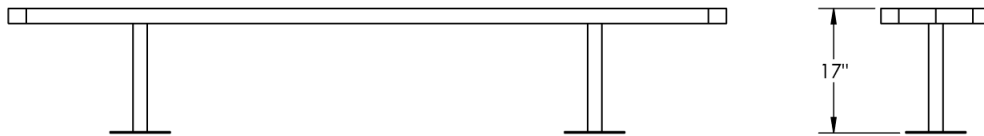
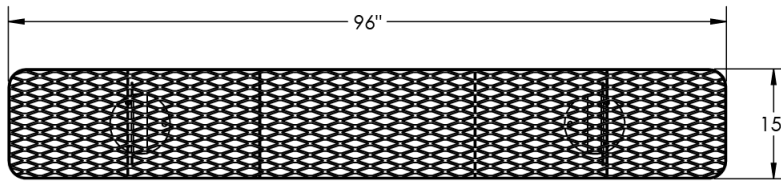
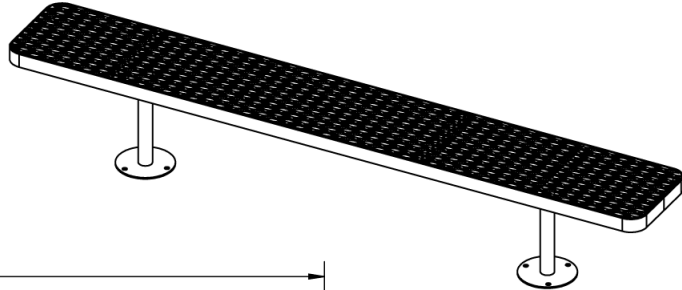

Part No.	Description	Qty.
622-115	8' Supreme Champion seat/back	1
633-111	Supreme Stand wo/Back (Surface mount)	2
516-058	3/8" x 1-1/2" SS Hex Bolt	4
516-028	3/8" SS Nylock Nut	4
516-023	3/8" SS Washer	8

- 1 Drill plastic out of the mounting holes on the stands and seat using a 7/16" dia. drill bit.
- 2 Fasten the seat to the stands loosely and then fasten the braces to the stands and seat.
- 3 Make sure bench is level and tighten all of the bolts.
- 4 Fasten to the floor with the appropriate fasteners.

In Accordance to California law: WARNING This product contains a chemical know to the State of California to cause cancer and birth defects or other reproductive harm.

*Periodic check of bolt tightness recommended.*



## PREMIER POLYSTEEL

The Best Commercial Outdoor Furniture Available. Period.





# 937-601

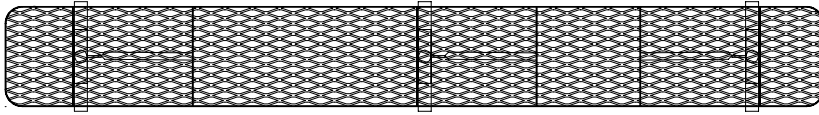

937-601 10ft  
SUPREME CHAMPION  
FREE STANDING  
BENCH WITHOUT BACK

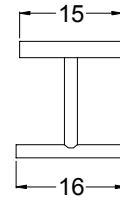
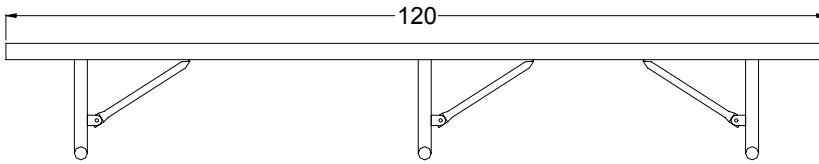

Part No.	Description	Qty.
622-116	10' Supreme Champion seat/back	1
631-110	Supreme Stand (WO/Back) (Free Standing)	3
631-313	Brace (WO/Back)	3
516-058	3/8" x 1-1/2" SS Hex Bolt	12
516-028	3/8" SS Nylock Nut	12
516-023	3/8" SS Washer	24

- 1 Drill plastic out of the mounting holes on the stands, seat and braces using a 7/16" dia. drill bit.
- 2 Fasten the seat to the stands loosely and then fasten the brace to the stands.
- 3 Make sure the bench is level and tighten all of the bolts.

In Accordance to California law: WARNING This product contains a chemical know to the State of California to cause cancer and birth defects or other reproductive harm.

*Periodic check of bolt tightness recommended.*



## PREMIER POLYSTEEL

The Best Commercial Outdoor Furniture Available. Period.







# 937-702

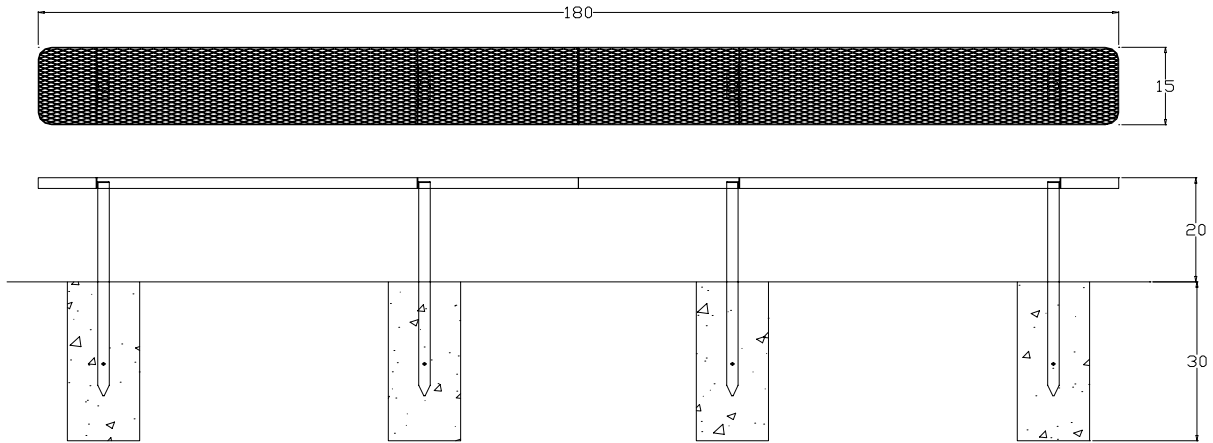

Part No.	Description	Qty.
622-118	7.5' Champion Seat/Back	2
631-020	Stand (Direct Bury)	4
516-058	3/8" x 1-1/2" SS Hex Bolt	10
516-028	3/8" SS Nylock Nut	10
516-023	3/8" SS Washer	20

- 1 Drill plastic out of the mounting holes on the stands and the seats using a 7/16" dia. drill bit.
- 2 Attach seats together with 3/8" x 1-1/2" SS hex bolts, washers and nuts and then mount stands to the seats with 3/8" x 1-1/2" SS hex bolts, washers and nuts.
- 3 Drill 4 holes (8"-10"Dia.) into the ground matching the spacing of the legs on the bench.
- 4 Support the bench in the holes with wood stakes.
- 5 Check the level and straightness of the bench and then fill the holes with concrete to within 2" of ground surface.

In Accordance to California law: WARNING This product contains a chemical know to the State of California to cause cancer and birth defects or other reproductive harm.

*Periodic check of bolt tightness recommended.*



## PREMIER POLYSTEEL

The Best Commercial Outdoor Furniture Available. Period.

